

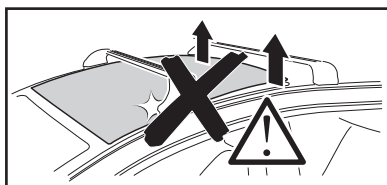

Thule Rapid System Kit 4055 Thule Podium Kit 4055

> Instructions

MERCEDES C-Class (W205), 5-dr Estate, 15-



This kit is only for vehicles with flush side railing.

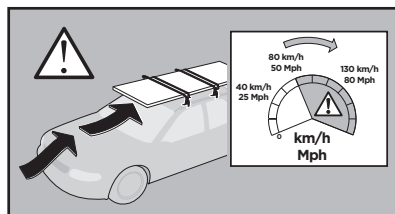
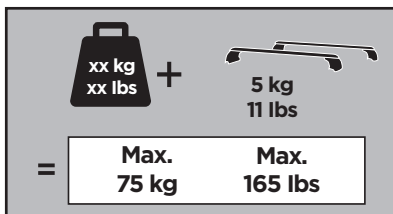
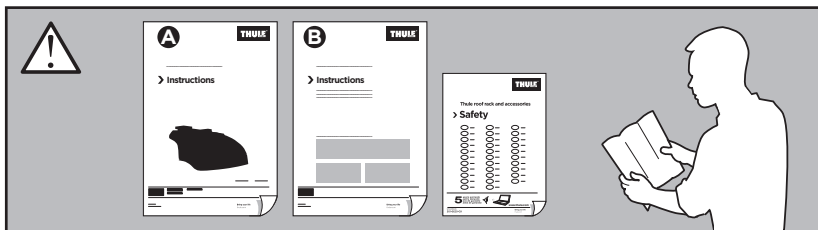

ISO 11154-E

184055
C.20150331
509-4055-02

Bring your life
thule.com

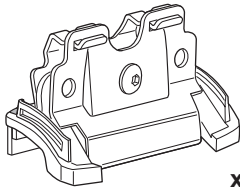

x4

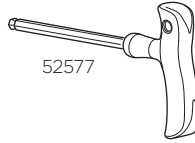

52577

x1

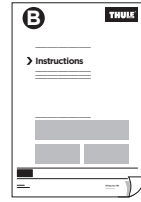

x1

1

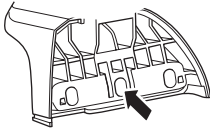

Thule Rapid System Foot Pack 753/7531
Thule Podium Foot Pack 460/460R

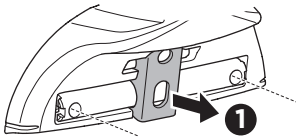

1

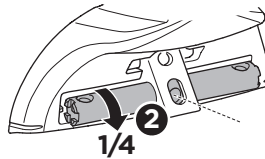

2
1/4

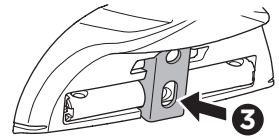

3

2

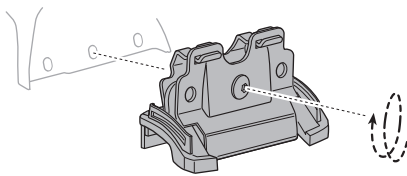

- EN Only a few turns
- DE Nur wenige Umdrehungen
- FR Quelques tours uniquement
- NL Slechts enkele slagen
- IT Solo qualche giro
- ES Sólo algunas vueltas
- PT Apenas algumas voltas
- SV Endast några varv
- DK Kun nogle få omgange
- NO Bare noen få omdreininger
- FI Vain muutama kierros

- ET Ainult mõni pööre
- LV Tikai daži apgriezieni
- LT Tik keli pasukimai
- PL Wystarczy kilka obrotów
- RU Только несколько оборотов
- UK Лише декілька обертів
- BG Само няколко завъртания
- CS Pouze několik otáček
- SK Len niekoľko otáčok
- SL Le nekaj obratov
- HR/BiH Samo nekoliko okreta
- RO Doar câteva rotiri
- HU Csak néhány fordítás
- EL Μόνο λίγες περιστροφές
- TR Yalnızca birkaç tur

بعض دورات فقط

AR

רק מספר סיבובים

HE

- ZH 仅几圈
- JA 2～3回転のみ
- KO 몇 번만 돌리면 됨
- TH เพียงสองสามรอบ

3

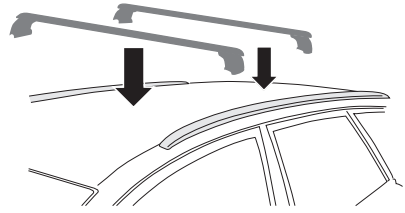
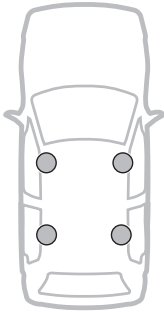

4

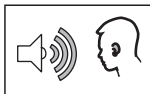
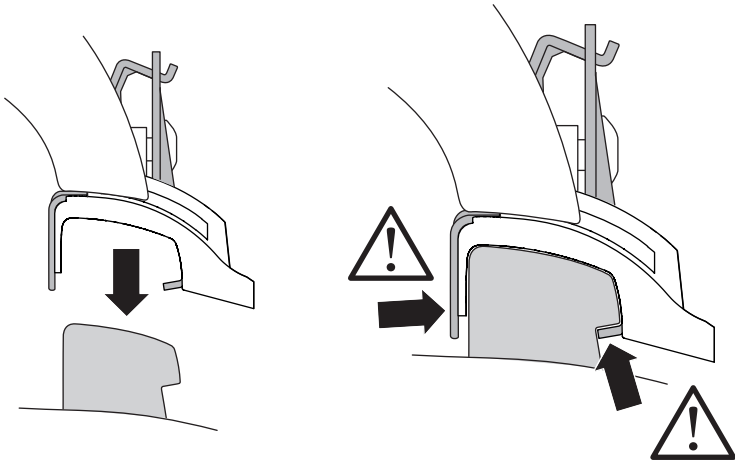

~ 700 mm

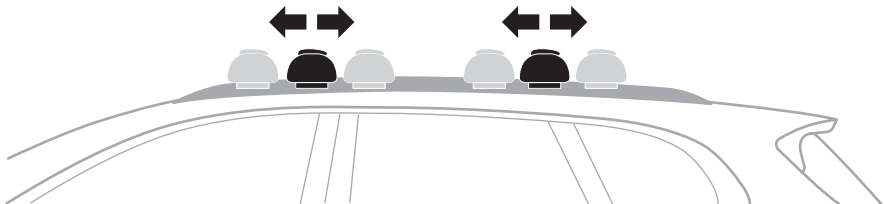
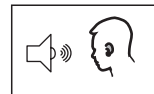

5

EN Tighten alternately
DE Die Schrauben abwechselnd anziehen
FR Serrer alternativement chaque côté
NL Afwisselend aan de linker- en de rechterkant aandraaien
IT Alternare il serraggio delle viti
ES Apretar alternativamente
PT Aperte alternadamente
SV Dra åt växelvis
DK Spænd skiftevis
NO Trekk til vekselvis
FI Kierrä vuorotellen
ET Pinguldage vaheldumisi
LV Pievelciet pamīšus
LT Užsukinėkite pakaitomis
PL Śruby dokręcaj naprzemiennie
RU Затягивайте попеременно

UK Затягти по чергово
BG Затегнете последователно
CS Pokręťta багаžníka dokręcaj dokręcaj naprzemiennie.
SK Dotahujte striedavo
SL Privijajte izmenično
HR/BIH Naizmjenično zategnite
RO Strângeți alternativ
HU Egymástól függetlenül szorítandó
EL Σφίγγετε εναλλάξ
TR Dönüşümlü sıkın

إحكام الربط بالتناوب **AR**חזק לסיורין **HE**

ZH 交替拧紧
JA 左右交互に締めつけてください
KO 번갈아 조이기
TH ขั้วในแบบสลับ

