

EN Fitting Instructions for Basic Carrier

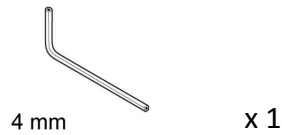

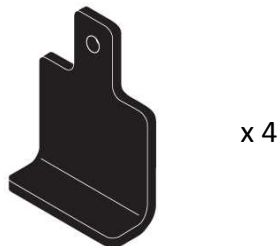
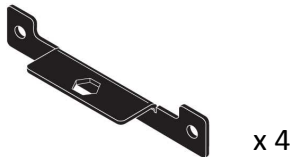
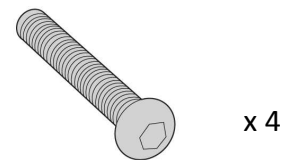
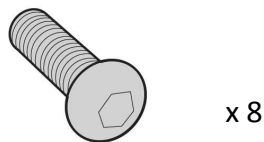
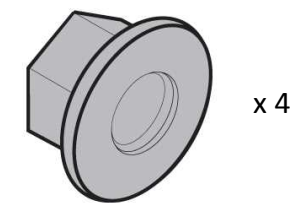
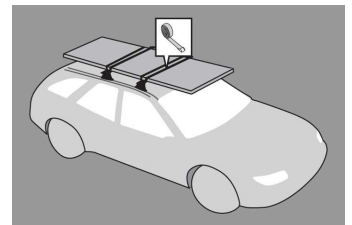
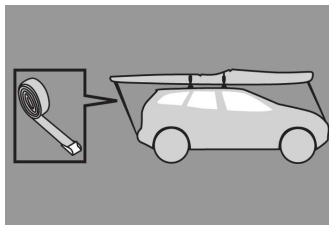
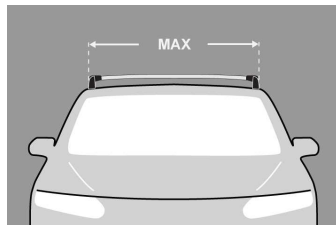
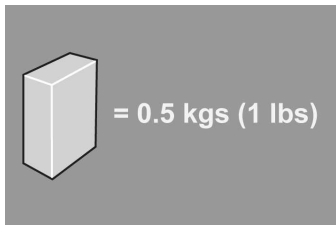
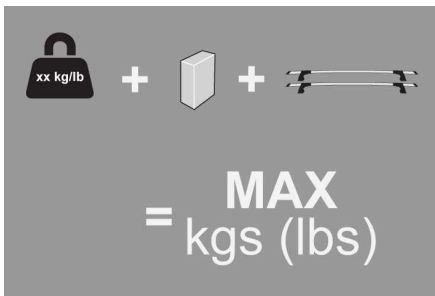

MAX kgs (lbs)

┆ W/P WHD

Nissan

Pathfinder R51, 5dr SUV 05-12

US 75 kgs (165 lbs)

Pathfinder R51, 5dr SUV 05-12

ZA 75 kgs (165 lbs)

Pathfinder R51, 5dr SUV 05-12

EU 75 kgs (165 lbs)

Pathfinder R51, 5dr SUV 05-Sep 13

AU 75 kgs (165 lbs)

Pathfinder R51, 5dr SUV 05-Sep 13

NZ 75 kgs (165 lbs)

First Time Installation

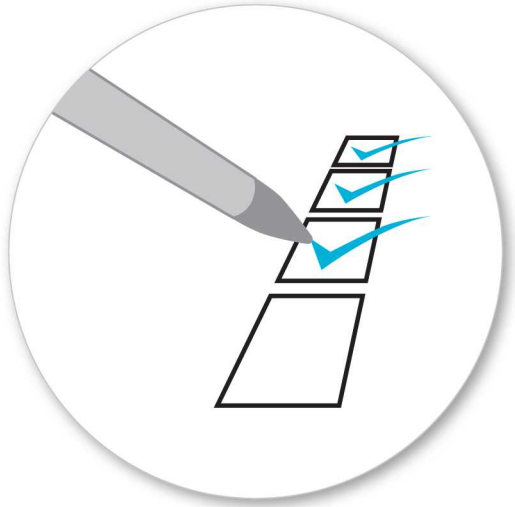

- Remove parts from inside the package and check. Contact your dealer if any parts are missing or damaged.



- Remove plastic screws as shown.



- Place bracket over holes.
- Fit the M6 socket head screw and M6 washer.
- Use hex key to tighten.
- Repeat for all four positions.

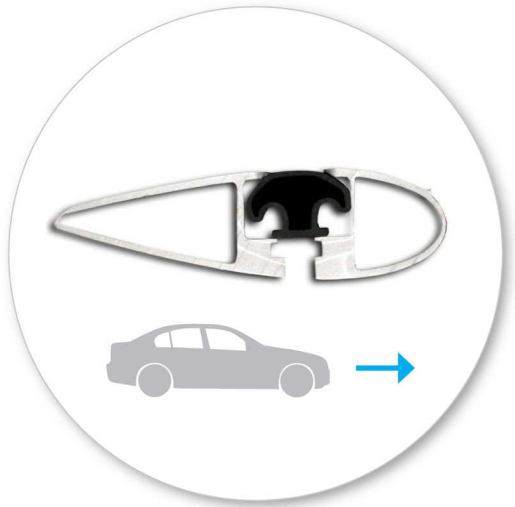

- Ensure the roof rack face towards the front of vehicle.



- Use keys to remove covers.
- While holding the key in the vertical position, pull the cover towards you to remove the cover.
- Repeat for all legs.



- Extend the leg out.
- Remove Hex Key by lifting and sliding out.



- Remove as shown.



- Remove clamp from leg.
- Store items away in a safe place.

Fitment

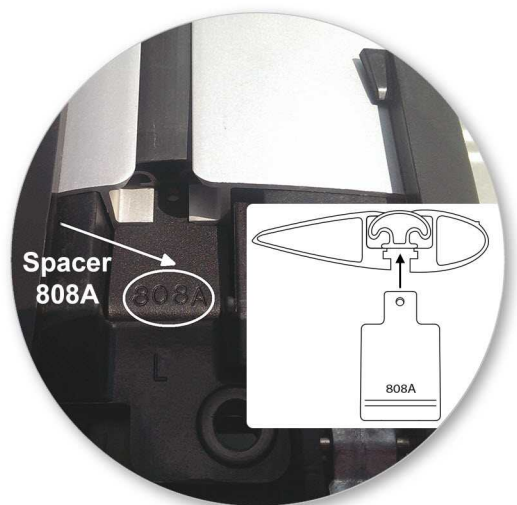

- Spacer 808A: Position as shown
- Repeat for all four positions.



- Crossbars should be parallel to each other and sit perpendicular to the roof rails.
- Repeat on other crossbar.

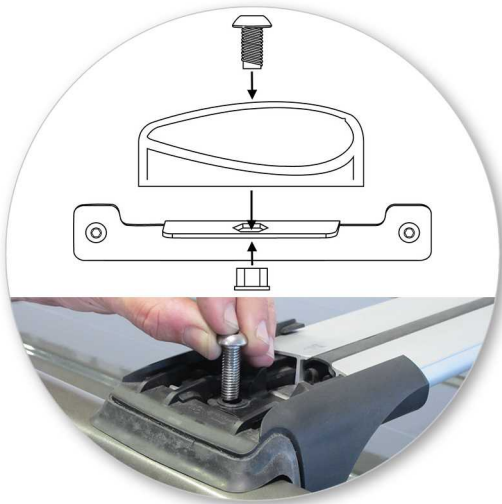

- Place screw into position.
- Screw small end of M8 flange nut onto M8 screw approximately 3 turns.
- Repeat for all four positions.



- Once crossbars are in position, tighten screw to 3 Nm (2.2 ft lb).
- Repeat for all legs.



- Slide Hex Key back into position into one of the roof rack legs.



- Ensure the locks on the legs are in the locked position (horizontal).
- Slide cover into the leg, You will hear a 'click' when the cover is securely locked.
- Repeat for all four positions.



- Check crossbar is securely attached to the vehicle.

**CAUTION: Recheck all fasteners immediately after a load is applied to the crossbars.
Regularly check screws are tight.**

Maintenance

- Long loads should be secured with non-elastic straps to the front and rear of the vehicle.
- Objects with pointed ends (e.g. ski poles) should be carried with the pointed ends to the rear of the vehicle.
- Remove all loose or removable objects from the load prior to loading.
- Make sure all loads are securely fastened with non-elastic straps. Check regularly during longer journeys.
- A loaded roof rack system can alter the performance of your vehicle. Be especially aware of the effects of side winds, changing of direction, and braking performance. Avoid rapid acceleration and deceleration. Drive carefully.
- Note that the total height of the vehicle increases when upright loads are carried.
- Products should be locked during transport if they have locks fitted.
- Check and replace worn out or defective parts.
- Keep the product clean and maintained.
- Never drive into a car wash with the roof rack system fitted.
- Lubricate locks and adjusting screws at regular intervals.
- Remove the products from the vehicle when not in use. Make sure all loose parts are stored safely.
- Clean the car roof and surfaces of the product that will be in contact with the car roof.
- Follow the fitting instructions for fitting the product to your vehicle. Make sure all steps are carried out in order.
- Set crossbars a minimum distance of 700mm (27 1/2") apart where no other distance is specified in the fitting instructions. This is especially important when carrying long loads.
- Check unit is securely attached whenever you refit it to the vehicle. If the unit feels loose, refer to the fitting instructions and readjust.

- Some glass/panoramic roofs and radio antennae may not be able to be used when the product is fitted.
- Do not modify this product.
- Refer to the maximum permitted load capacity specified in the fitting instructions. Do not exceed the vehicle manufacturers roof load rating if it is lower than the maximum load capacity specified in the fitting instructions.
- Loads should not overhang the sides of the product and be evenly distributed with the lowest possible centre of gravity.

Accessories Available for this Product:

- Roof Box
- Ski, Snowboard Carrier
- Canoe, Kayak Carrier
- Bicycle Carrier
- For more accessories please see our product catalogue.

-
- Yakima Australia Pty Ltd
17 Hinkler Court
Brendale QLD 4500
AUSTRALIA

www.whispbar.com
www.whispbar.com.au
www.whispbar.co.nz
www.whispbar.co.uk
www.whispbar.co.za
www.whispbar.eu
www.whispbar.ca

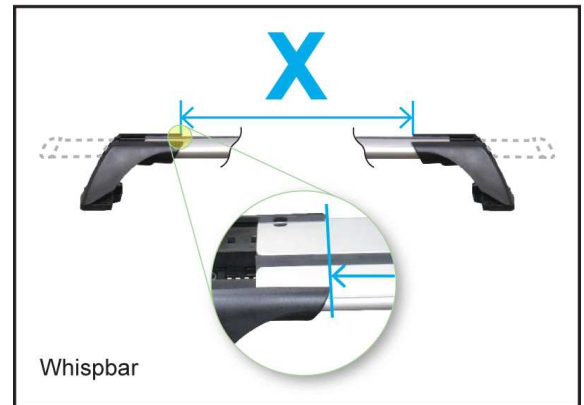
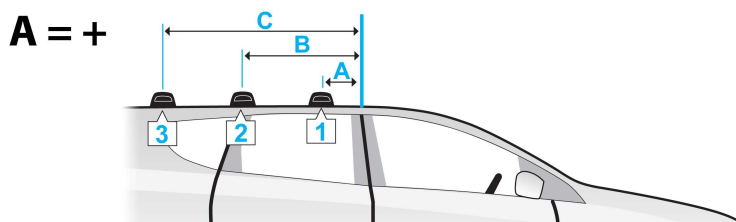
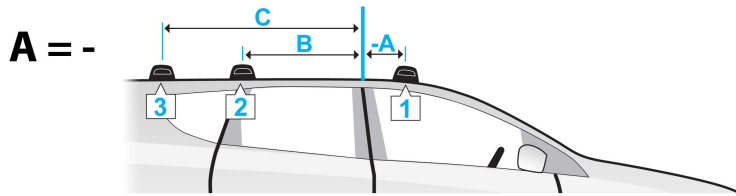

	A	B	C	X		
				1	2	3
Pathfinder, 5dr SUV 05-12 (US)	390mm	1110mm	-	725mm	725mm	-
	15 3/8ths"	43 11/16ths"	-	28 9/16ths"	28 9/16ths"	-
Pathfinder, 5dr SUV 05-12 (ZA)	390mm	1110mm	-	725mm	725mm	-
	15 3/8ths"	43 11/16ths"	-	28 9/16ths"	28 9/16ths"	-
Pathfinder, 5dr SUV 05-12 (EU)	390mm	1110mm	-	725mm	725mm	-
	15 3/8ths"	43 11/16ths"	-	28 9/16ths"	28 9/16ths"	-
Pathfinder, 5dr SUV 05-Sep 13 (AU)	390mm	1110mm	-	725mm	725mm	-
	15 3/8ths"	43 11/16ths"	-	28 9/16ths"	28 9/16ths"	-
Pathfinder, 5dr SUV 05-Sep 13 (NZ)	390mm	1110mm	-	725mm	725mm	-
	15 3/8ths"	43 11/16ths"	-	28 9/16ths"	28 9/16ths"	-

WARRANTY & DISCLAIMER

Yakima Australia Pty Ltd ABN 58 154 440 221
17 Hinkler Court, Brendale QLD 4500
Tel: 0800 4776 722 (NZ) or 1800 143 548 (AU)
Email: warranty@yakima.co.nz or warranty@yakima.com.au

1. Where the product is supplied to the customer for other than business purposes within the meaning of section 43 of the New Zealand Consumer Guarantees Act 1993, the provisions of that Act shall apply. It is important that anyone who fits or uses this product does so in accordance with the manufacturer's instructions.
2. Where the product is supplied to the customer for business purposes within the meaning of section 43 of the New Zealand Consumer Guarantees Act 1993, the provisions of that Act and all other representations or terms (including any conditions or warranty expressed or implied by law, statute or otherwise) not expressly included in this leaflet are hereby expressly excluded shall have no effect and the clauses (a) and (b) shall apply.
3. Subject to the **Additional Information (Australia)**, where the product is supplied and purchased in Australia, the following shall apply:
 - a. THE SUPPLIER WARRANTS the product to be free from defects in materials and/or workmanship for a period of three (3) years from the date of original purchase (the warranty period). Proof of purchase is required. Subject to the limitations and exclusions set out below, the Supplier hereby agrees to remedy any defects in materials or workmanship becoming apparent during the warranty period, by replacing or repairing any defective product or component (at its option) free of charge to the purchaser in respect of replacement parts or labour. Any defective product or component must be notified and where practicable, returned at the purchaser's expense to the Supplier immediately upon discovery of the alleged defect and no attempt made on the part of the purchaser to repair it.
 - b. **EXCEPTIONS, EXCLUSIONS AND LIMITATIONS TO WARRANTY.** The product and/or its components must be fitted/ assembled and loaded in accordance with the Supplier's written instructions and any requirements set out in the car's owner manual. This warranty does not cover defects, loss or damage resulting from circumstances beyond the Supplier's control including, but not limited to misuse, overloading, or failure to assemble and/or fit the product or component in accordance with the Supplier's written instructions. Nor does the warranty cover defects, loss or damage resulting from accidents, unlawful use of the vehicle or defects/inconsistencies in the vehicle on which the product or component is fitted. Liability for direct, indirect, special, punitive, incidental, exemplary, contractual or consequential damage or loss arising from defects, faulty materials or design omissions or negligence or workmanship in the product or its components is hereby expressly excluded subject to the following. Certain Commonwealth legislation, including the Competition and Consumer Act 2010 (Cth), and other State and Territorial legislation confers upon purchasers rights which cannot be excluded from or be restricted or modified by contract. Any conditions, guarantees and/or warranties implied by law and incapable of exclusion are deemed to be expressly incorporated herein. Nothing herein contained is intended nor shall be permitted to be inconsistent with any such conditions, guarantees and/or warranties. To the extent permitted by legislation all conditions, guarantees and/or warranties such as implied warranties which are capable of exclusion are hereby expressly excluded and negated.

ADDITIONAL INFORMATION (AUSTRALIA)

This information should be read in conjunction with clauses (a) and (b).

IMPORTANT LEGAL NOTICE

Our goods come with guarantees that cannot be excluded under the Australian Consumer Law. You are entitled to a replacement or refund for a major failure and for compensation for any other reasonably foreseeable loss or damage. You are also entitled to have the goods repaired or replaced if the goods fail to be of acceptable quality and the failure does not amount to a major failure.

This warranty does not change or take away your rights under the Australian Consumer Law. Your right to claim under this policy for the benefits covered is in addition to other rights and remedies you have under the law in relation to the product.

Where you become aware of defects in materials or of workmanship, and wish to make a claim under this warranty you must do the following for the warranty to be honoured by your Prorack dealer or Yakima Australia Pty Ltd ABN 58 154 440 221 (Yakima):

1. Make a claim as soon as practicable by contacting the Prorack dealer from whom you purchased the product, who will give you instructions on how to proceed.
2. If you are unable to contact the Prorack dealer, or the dealer is not able to remedy the defect, you should contact Yakima as soon as practicable at:

Call: 0800 4776 722 (NZ) or 1800 143 548 (AU)
 Email: warranty@yakima.co.nz or warranty@yakima.com.au

Alternately, you can write to Yakima at 17 Hinkler Court, Brendale QLD Australia 4500 in order to make a claim under your warranty.

3. Upon contacting Yakima directly, you should explain as fully as possible the defect. A Yakima representative will provide you with appropriate instructions for returning the product together with a copy of the original purchase invoice or receipt to Yakima.
4. The costs and expenses associated with making a claim under your warranty including the costs of complying with those instructions and of returning the product to Yakima or the Prorack dealer will be borne by you.

Following receipt of the product and purchase invoice or receipt, Yakima or the Prorack dealer must inspect the product to determine whether the claim falls within the warranty. If:

- 4.1 the claim falls within the warranty, Yakima will remedy any defects in materials or workmanship becoming apparent during the warranty period, by replacing or repairing any defective product or component (at its option) free of charge to the purchaser in respect of replacement parts or labour.
- 4.2 the claim does not fall within the warranty, Yakima will return the product to you at your expense.