

# Kit 1388

HYUNDAI Sonata, 4-dr Sedan, 05- / \*06-10

\*North America

480R  
754

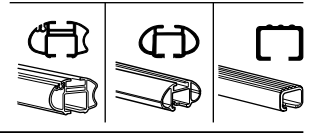
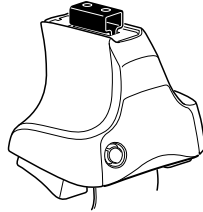

480

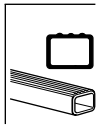
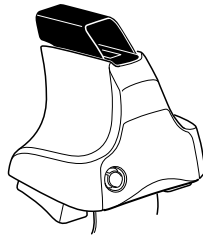

750

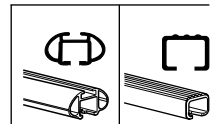
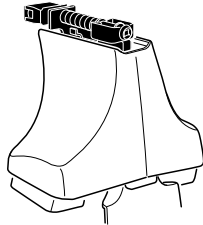

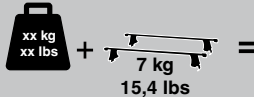

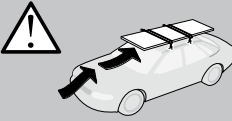

**Max. 60 kg**  
**Max. 132 lbs**

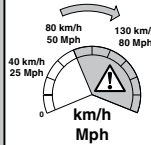

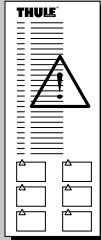

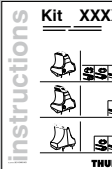

**Kit XXXX**  



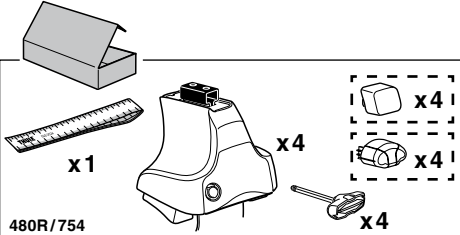

**480R/754**  
**x1** **x4** **x4** **x4**

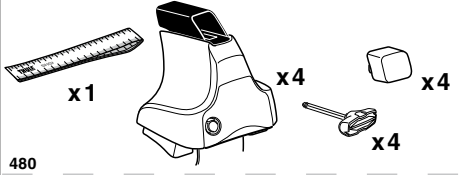

**480**  
**x1** **x4** **x4** **x4**

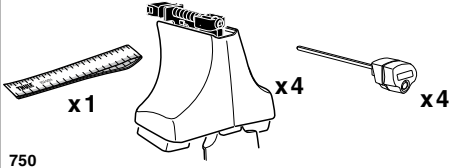

**750**  
**x1** **x4** **x4**

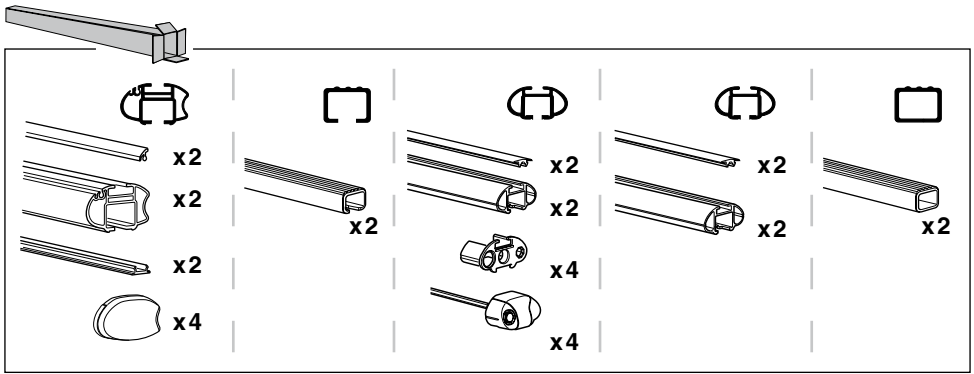

**x2** **x2** **x2** **x4**

**x2** **x2** **x2** **x4** **x4**

**x2** **x2** **x2** **x2**

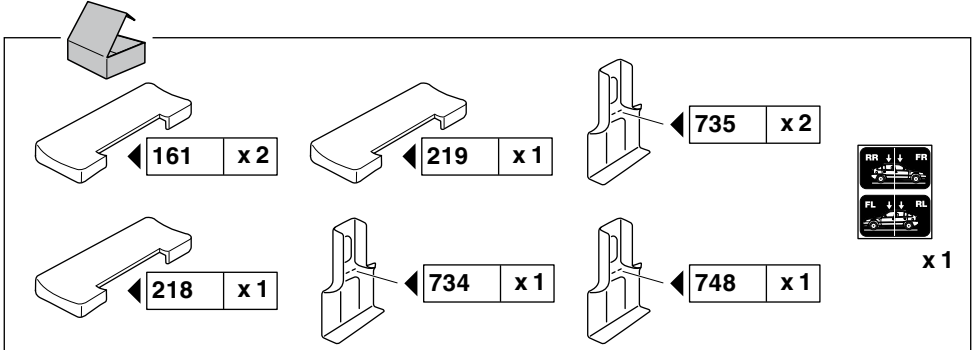

**161 x2** **219 x1** **735 x2**

**218 x1** **734 x1** **748 x1**



**x1**

**Kit**



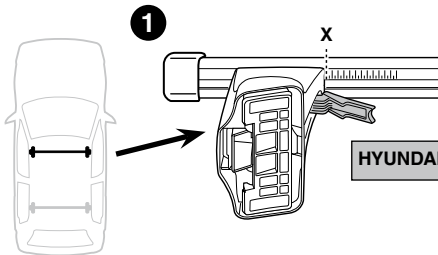

|   |                         |
|---|-------------------------|
| <b>HYUNDAI Sonata, 4-dr Sedan, 05- / *06-10</b> | <b>X</b><br><b>42,5</b> |
|---|-------------------------|

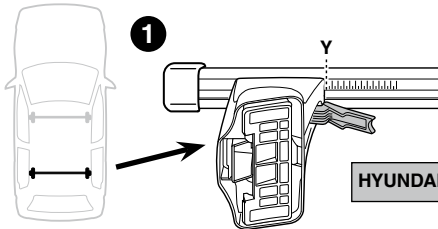
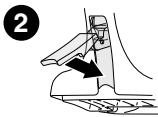

|   |                       |
|---|-----------------------|
| <b>HYUNDAI Sonata, 4-dr Sedan, 05- / *06-10</b> | <b>Y</b><br><b>39</b> |
|---|-----------------------|

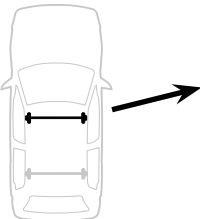
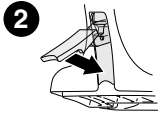

|   |                                 |                               |
|---|---------------------------------|-------------------------------|
| <b>HYUNDAI Sonata, 4-dr Sedan, 05- / *06-10</b> | <b>X inch</b><br><b>42 3/8"</b> | <b>X mm</b><br><b>1076 mm</b> |
|---|---------------------------------|-------------------------------|

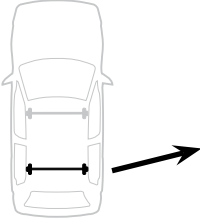
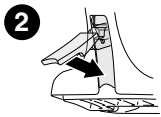
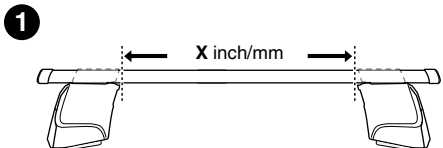

|   |                             |                               |
|---|-----------------------------|-------------------------------|
| <b>HYUNDAI Sonata, 4-dr Sedan, 05- / *06-10</b> | <b>Y inch</b><br><b>41"</b> | <b>Y mm</b><br><b>1041 mm</b> |
|---|-----------------------------|-------------------------------|

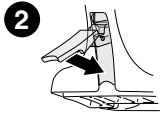
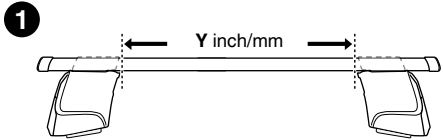

# 4

HYUNDAI Sonata, 4-dr Sedan, 05- / \*06-10

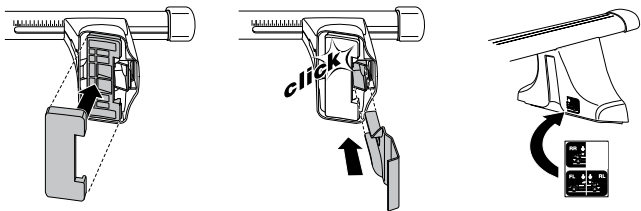
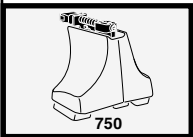
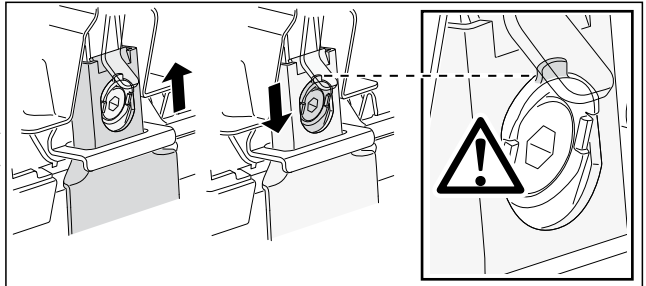
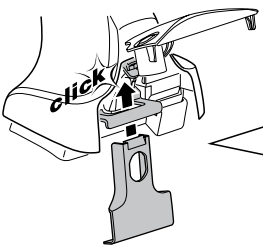
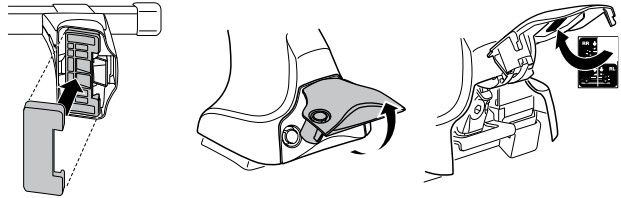
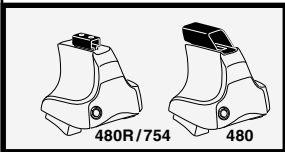
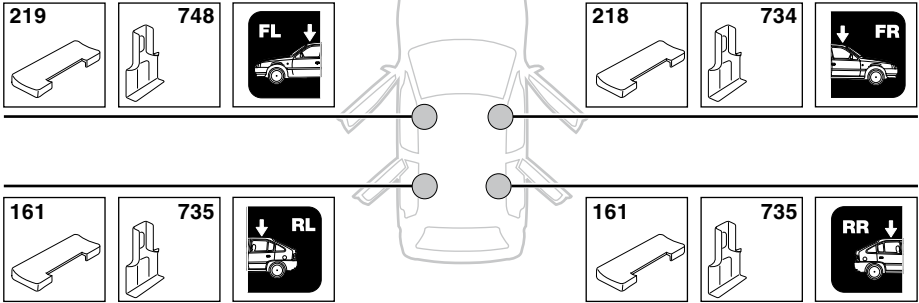

5

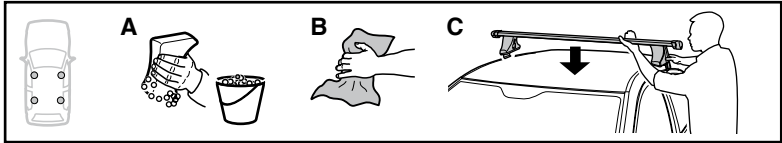

|   | X mm          | Y mm          | X inch    | Y inch         |
|---|---------------|---------------|-----------|----------------|
| <b>HYUNDAI Sonata, 4-dr Sedan, 05- / *06-10</b> | <b>230 mm</b> | <b>670 mm</b> | <b>9"</b> | <b>26 7/8"</b> |

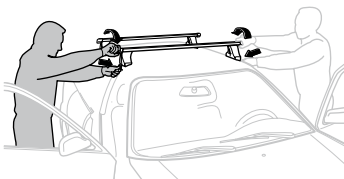
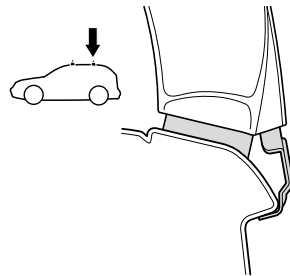
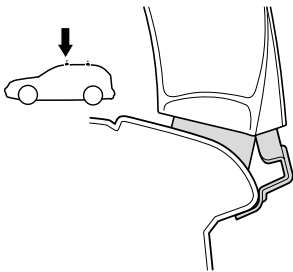
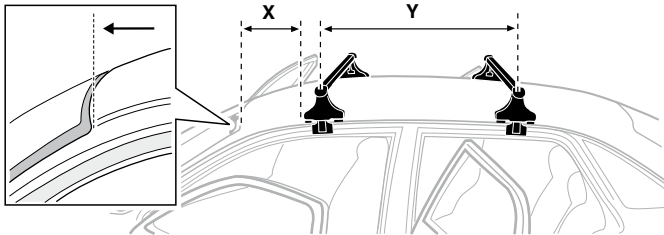

**GB/US** Tighten alternately

**D** Die Schrauben abwechselnd anziehen

**F** Serrer alternativement chaque côté

**NL** Afwisselend aan de linker- en de rechterkant aandraaien

**I** Alternare il serraggio delle viti

**E** Serrare alternativamente

**PT** Aperte alternadamente

**S** Dra åt växelvis

**FIN** Kierrä vuorotellen

**EST** Pinguldage vaheldumisi

**LAT** Pievelciet pamišus

**LIT** Užsukinėkite pakaitomis

**PL** Śruby dokrecaj naprzemiennie

**RU** Затягивайте попеременно

**CZ** Pokreťta багаžníka dokrecaj dokrecaj naprzemiennie.

**SK** Dotahujte striedavo

**SLO** Privijajte izmenično.

**HR** Naizmjenično zategnite

**HU** Egymástól függetlenül szorítandó

**GR** Σφιγγετε εναλλάξ

**TR** Dönüşümlü sıkın

**中文** 交替拧紧

**한국어** 번갈아 가며 조이십시오.

**日本語** 交互に締め付けてください。

**ไทย** ชั้้นในแบบสลับ

6



480R/754



480



\*  
3 Nm



\*



\*  
≈ 3 Nm

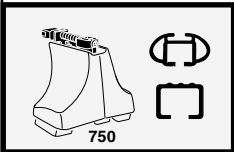
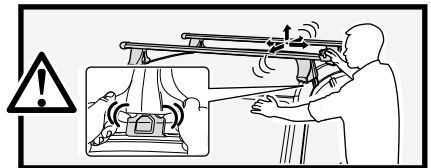

750

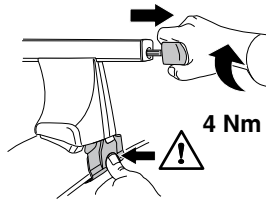

4 Nm

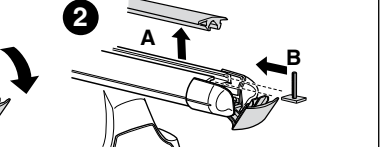
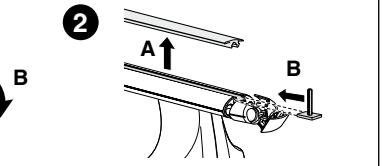
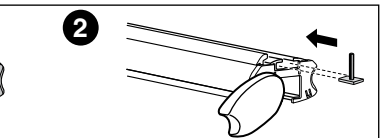
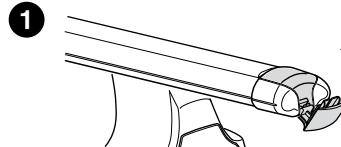
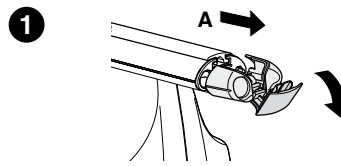
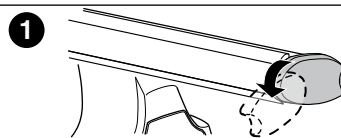
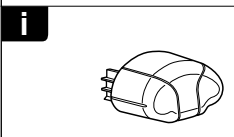
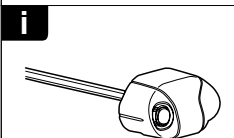
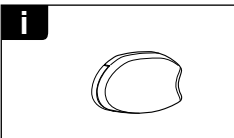
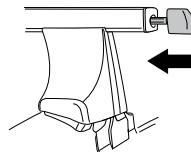



**THULE**  
SWEDEN  
**ONE  
KEY  
SYSTEM**

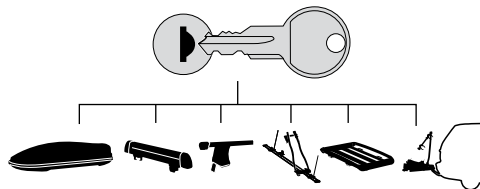

|      |  |       |
|------|--|-------|
|      |  | (x4)  |
|      |  | (x6)  |
|      |  | (x8)  |
| NA   |  | (x10) |
| EUR  |  | (x12) |
| ASIA |  | (x12) |

